



LOKE Conespreader

User Manual

Martin Munkeby

1 CONTENTS

2 Content	2
3 SAFETY	3
3.1 General safety	3
3.2 Receiving new equipment	3
3.4 Disinfecting equipment	3
3.5 Staff Security	3
3.6 Severe Weather	3
4 About NorseAqua AS	4
Contact information	4
5 About Loke Conespreader	5
1. Parts of the product	5
Specifications for Loke Conespreader	6
Specifications Loke base	6
5.2 Competence requirements for use.	6
5.3 Identification of the product	6
5.4 Life expectancy	6
Thresholds for normal use	6
5.6 Assessments of escape risk	7
How to count the risk of escaping.	7
Risk matrix- Risks of escapes	7
6 Installation	8
6.1 Equipment	8
6.2 Installation on land before exposing	9
6.3 Fixing Jaws on base	10
6.3.1 Setting the Spread	10
6.4 Expose to Sea	12
Lift the spreader into the cage.	12
Connecting the Feed Hose	13
Fixing Method 1 – Four Ropes	14
Fixing Method 2 – Three Ropes	14
6.5 Installation of the Loke conespreder to another float	15
7 Use – Best Practices	15
7.1 Before feeding	15
7.2 Adjust spread image	16
8 Maintenance	16
8.1 Periodic inspection and maintenance	16

8.2 Spare parts and service-----	16
8.3 Icing-----	16
8.4 Storage and Storage -----	16
8.5 Traceability -----	16
8.6 Conditions and limitations of use -----	16
9 Shipping -----	16
10 Storage -----	17
11 Troubleshooting -----	17
12 Alteration, rebuilding or expanding -----	17
13 Throwing/disposing -----	17

2 CONTENT

The userguide describes how the product should be:

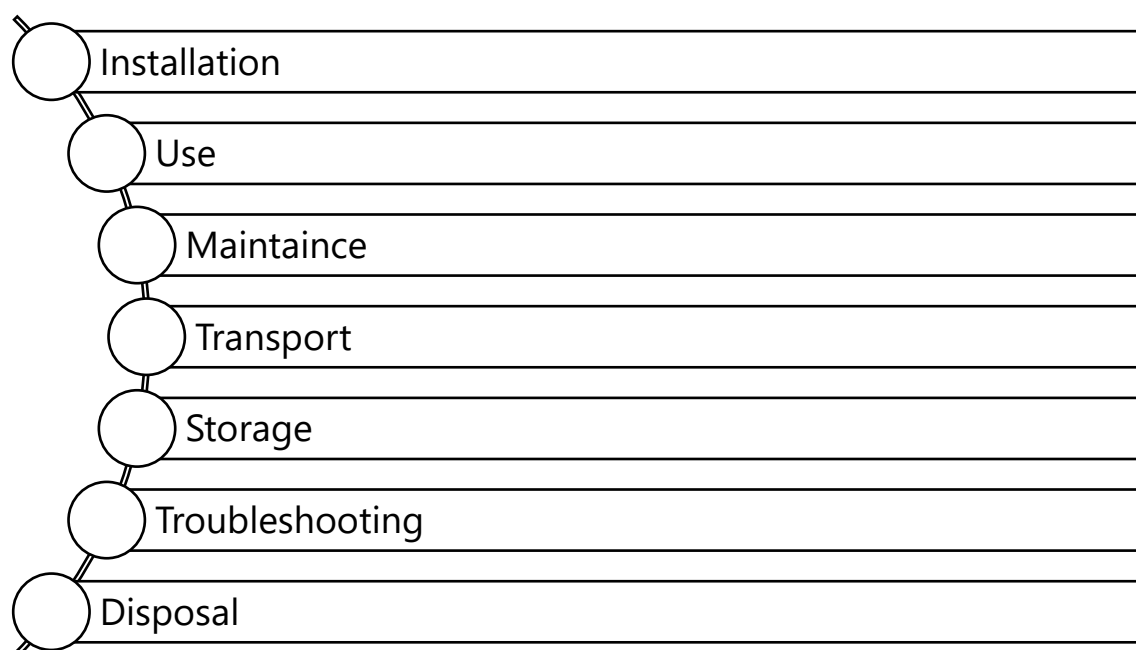

Please contact us if you find things that are unclear and we will help you as best we can.

3 SAFETY

3.1 GENERAL SAFETY

This manual describes how to use the product safely. Other tasks may only be performed by NorseAqua personnel, or after a written APPROVAL from NorseAqua AS.

Those who own the facility where the product is installed is responsible for:

- That the applicable laws and regulations of the country where the facility is installed is followed.
- That the necessary safety devices to protect staff work are in place.
- That the product is installed correctly.

Those who operate the product should be familiar with:

- How the product works and how to use it.
- How the product works in conjunction with the rest of the facility.
- What safety considerations should be taken in relation to the use, maintenance and other tasks with and around it.
- How it should be maintained according to the procedure of this manual.

3.2 RECEIVING NEW EQUIPMENT

Check that all parts specified in the packing list are shipped. If the order is not complete, or if something has been damaged in transit, please contact NorseAqua.

3.3 DISINFECTING EQUIPMENT

Should equipment, ropes and other related equipment be moved from one site to another, it is legally required to disinfect everything in order to prevent any infection. We recommend rinsing the equipment with fresh water after disinfection, as disinfectants often have very harsh chemicals that can cause damage to materials.

3.4 STAFF SECURITY

Anyone who will operate the product must understand how to use the equipment and gain knowledge about possible hazards if from improper use. The owner and operations manager of the facility is responsible for all employees having understood the contents of this manual. Protective equipment, such as non-skid footwear and flotation garments, are mandatory when staying on the edge, for example in connection with the installation and maintenance of the spreader. To avoid damage to personnel and equipment during installation, maintenance and repair of the product, it is important to follow all instructions provided by NorseAqua in this manual and to comply with the laws and regulations applicable in the country in which the equipment is installed.

3.5 SEVERE WEATHER

Check all equipment after storms and severe weather. If equipment has been damaged, it must be corrected immediately. Take contact with NorseAqua for assistance in such cases.

3.6 TRACEABILITY

All our conespreaders quality have internal controls and are applied to an embossed serial number. This is to ensure that the product keeps the quality and safety that we require. If there are any problems, please contact us so that we can secure ourselves against similar incidents. Give us the serial number so we can track the product.



4 ABOUT NORSEAQUA AS

NorseAqua aims to be an important piece on the way to the goal of 5 million tons of Norwegian sustainably produced seafood in 2050. NorseAqua is therefore working to find solutions to the main challenges in the aquaculture industry.

This happens in cooperation with our customers. We therefore want feedback about us and the equipment we provide. We'd also like to hear from you if you have a challenge. We are good at finding solutions.

CONTACT INFORMATION

Company
NorseAqua AS
 Tel: +47 975 00 008
post@norseaqua.no
 Sørfjordsveien 5
 7980 Terråk
 Norway
 Org.nr: 916 547 358 MVA

Product Manager
Martin Munkeby
 +47 484 10 290
martin@norseaqua.no

Managing Director
Sveinung Kristiansen
 +47 975 00 08
sveinung@norseaqua.no

5 ABOUT LOKE CONESPREADER

1. PARTS OF THE PRODUCT

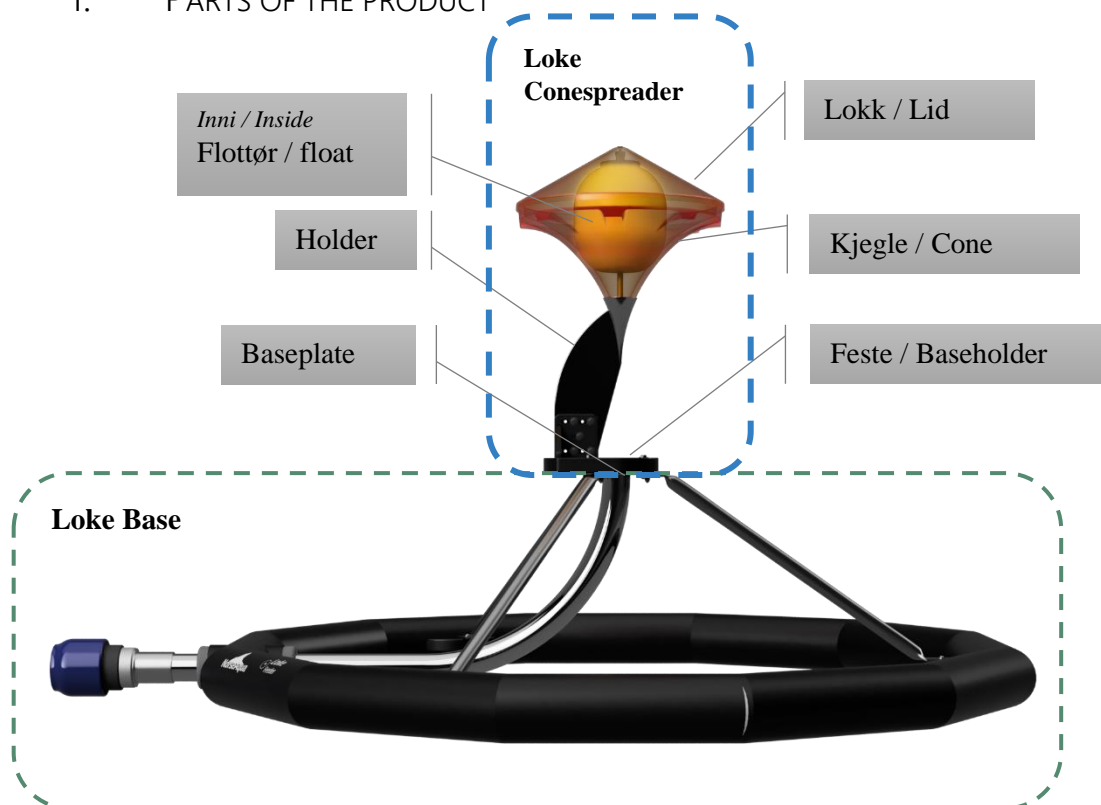

Specifications for Loke Conespreader

Property	Value	Description
Size	570x570x900mm	
Weight	17 kg	

Specifications Loke base

Property	Value	Description
Size	2650x2220x600mm	Assembled extent
Base Diameter	2300mm	Diameter
Weight	50 kg	

5.2 COMPETENCE REQUIREMENTS FOR USE.

Installation of the spreader does not require any training other than that written in this user manual.

5.3 IDENTIFICATION OF THE PRODUCT

5.3.1.1 Loke Conespreader

Contact NorseAqua to identify the product.

5.3.1.1 Loke Base

Contact NorseAqua to identify the product.

5.4 LIFE EXPECTANCY

The product is expected to function 60 months in the sea given that maintenance routines are followed.

THRESHOLDS FOR NORMAL USE

	Verdier	Kommentar
<i>Significant wave height (H_s)</i>	5	
<i>Current (m/s)</i>	3	
<i>Wind (m/s)</i>	40	
<i>Ice(cm/day)</i>	5	

These limits require proper installation and operation.

5.6 ASSESSMENTS OF ESCAPE RISK

How to count the risk of escaping.

Points	How likely is it for the accident to occur?	Example	What is the consequence of the accident occurring?	Example
5	Very much likely	Monthly	Very serious	Facility-level escapes may occur.
4	Very likely	Once a year or more often	Serious	The merd/vessel level escapes may occur in special cases.
3	Likely	Once per 5 years	Moderate	Individual escapes can happen.
2	Less likely	Once per 10 years or more often	Potential	Individual escapes can happen in very special cases
1	Unlikely	Less often than every 10 years	Insignificant	Negligible risk

Risk matrix- Risks of escapes

Point	Danger	Cause of danger	Probability	Consequences	Risk	Measures
1	Chafing on net	Two fixing ropes loosen and the ring hangs in the net	1	4	4	Correct fixing and inspection. The aerator is made such that it hangs free at the desired depth. The aerator has no sharp edges.
2	Tearing of net	Damage to the ring exposes sharp edges that come into contact with the net	1	4	4	Correct fixing and inspection with underwater camera
3	Can fall into the net, be hanging against the net	Suspension failure.	1	4	4	Inspection with underwater camera
4	Deformation of main component	Too heavy load on the handrail if the ring hooks onto other components	2	4	8	Inspection with underwater camera
5	Secondary damage to main component	–	0	0	0	



6	Short circuit and fire (net and float collar)	–	0	0	0	
7	Water intrusion (power cabinet for components)	–	0	0	0	
8	Icing hazard	Icing on ropes causes them to loosen or overload the handrail	1	4	4	Breaking/melting of ice
9	Corrosion, loss of initial strength	Negligible weakening in components due to corrosion and sun damage in the product's lifetime	1	4	4	Inspection
10	Production defects, fatigue	Production defects can cause breakage in special cases	2	4	8	Welding inspection in production
11	Different practices for installation and operation	Increases likelihood of the dangers mentioned above	3	4	12	Good user manual. Offer assistance with installation.
12	Not notice / not notify about the accident	Increases likelihood of the dangers mentioned above	3	4	12	Good user manual. Offer assistance with installation.



6 INSTALLATION

Installation consists of two main steps:

1. Installation on land before exposing
2. Expose

6.1 EQUIPMENT

Equipment	Comment
 <p>Torque Wrench</p>	Torque M8 screws av A4-80 degree: 26.7 NM
 <p>Two Peeler</p>	
 <p>Surround wrench with key width 13mm</p>	Alternative to ratalle.

 <p>Two pipes 13mm</p>
 <p>Two Union Keys NRF nr: 2534521</p>
 <p>Two hexagon keys 6mm</p>

6.2 INSTALLATION ON LAND BEFORE EXPOSING

1. Unpack the conespreader and check the packing list to check that all parts are included in the delivery.
2. Attach the bars to the aviator.



1. Bend up the feed tube and tighten everything that holds it in place.

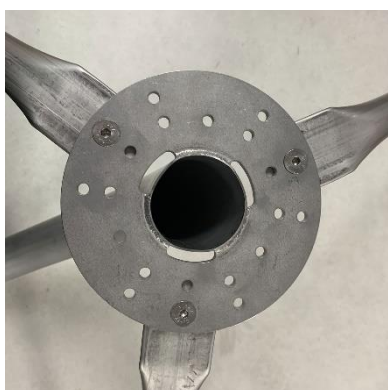

1. Assemble the carrying of the feed pipe in the base.

6.3 FIXING JAWS ON BASE

1. Tighten the bracket firmly in the base with the fastening grooves against the feed pipe.
 - a. The fixture should point to the feed pipe.



1. Use four screws.

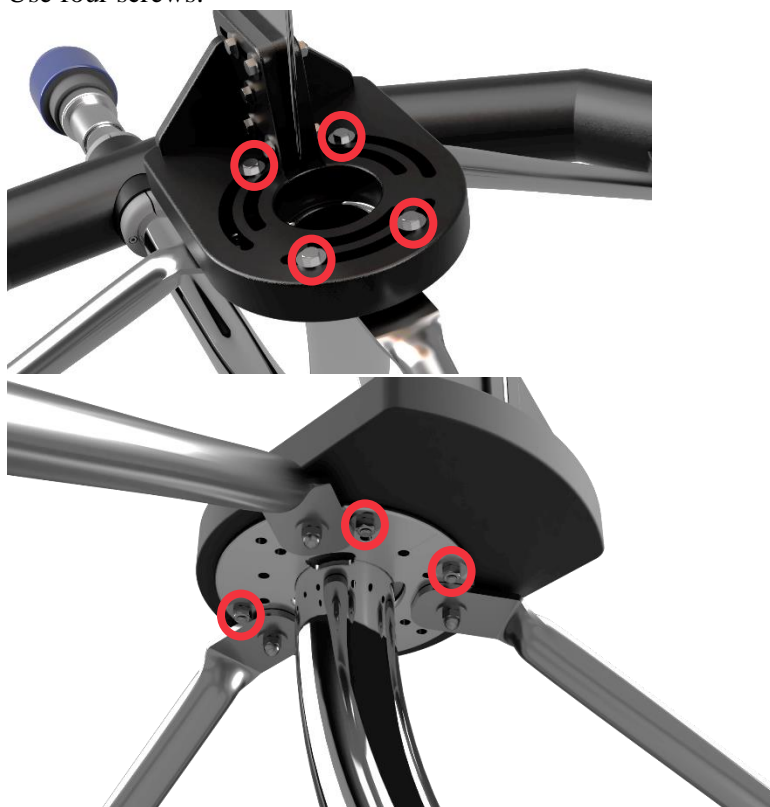

6.3.1 Setting the Spread

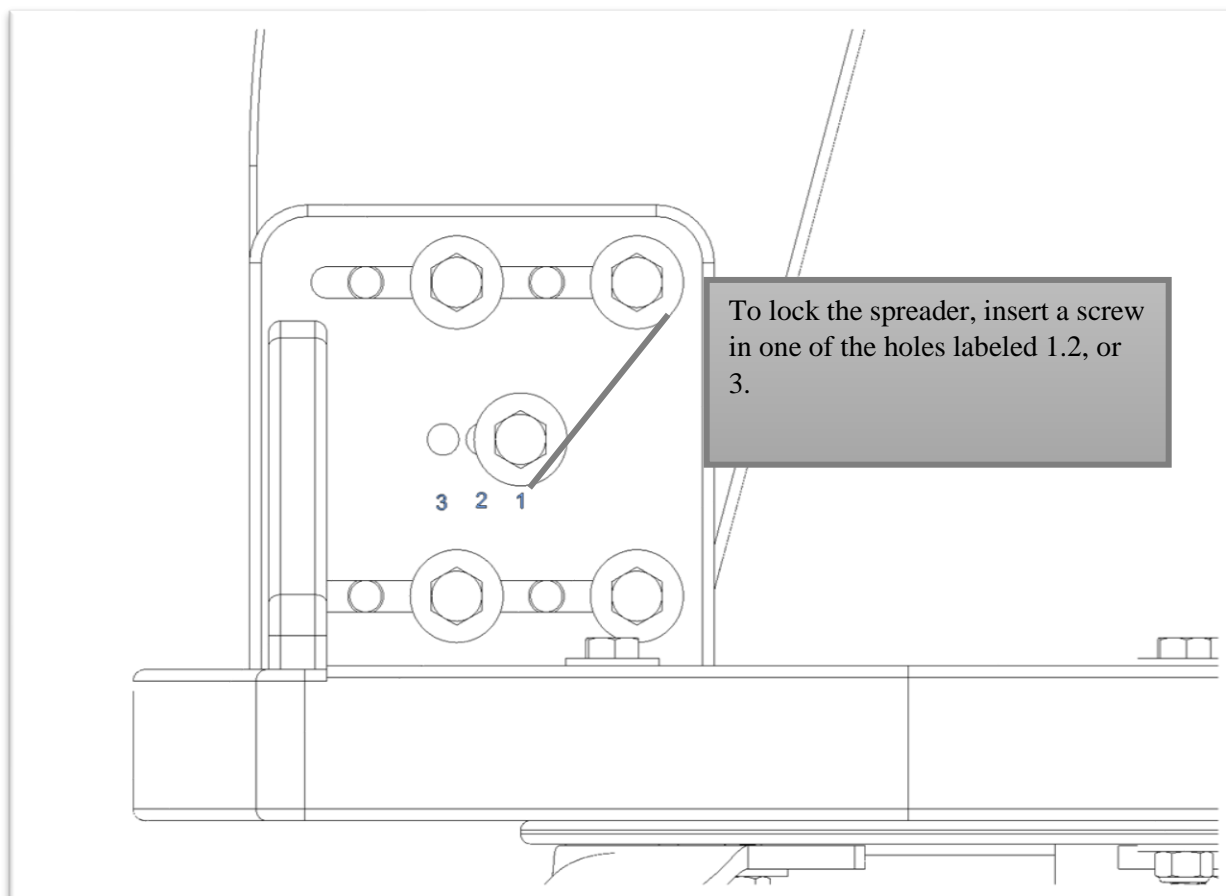
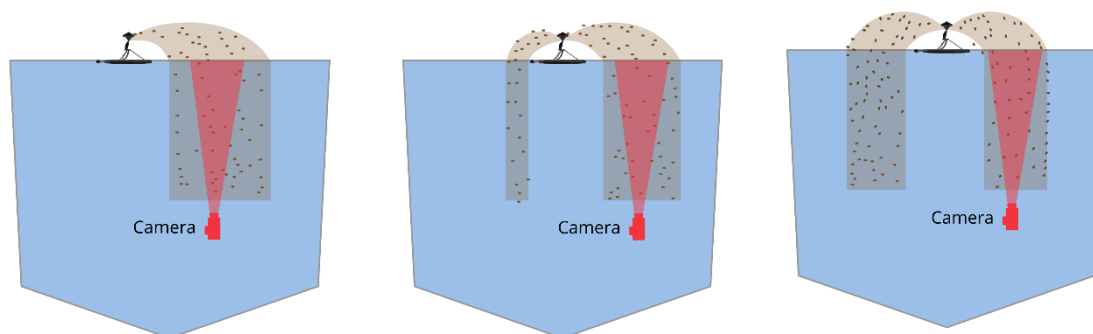

Each raft, diffuser and hose is different, so you need to adapt to the position of your facility.

Suggestion for setting: Smoltfeeding position

Growthfeeding Position

<i>Loke Base</i>	1	3
<i>Akva Hex base</i>	1	3
<i>Akva RS-90C</i>	1	3

6.4 EXPOSE TO SEA

Lift the spreader into the cage.

Follow your company's procedure for secure lifting operations.

1. After you have mounted the spreader, take it to the cage.
2. Attach two approved lifting straps to the spreader and hook into the faucet.
3. Make sure the lift is safe.
4. Lift the spreader into the cage.
5. Attach one of the fixing points to the hand list so that the spreader does not drift into the cage.



6.

7. We recommend using the knot with a double half stroke (ABOK 1720).

Connecting the Feed Hose

MAGNUM installasjon



1. Kapp røret rett og avrund rørendene.



2. Marker innstikkdybden på rørenden. Instikkslengden er markert på koblingen.



3. Løsne mutteren uten å ta den av, sett så røret inn i kontakten til riktig dybde er nådd.



4. Stram til koblingen med hendene. For størrelser over d25, stram ekstra med en spesial nøkkel for magnum koblinger.

Retrieved from FDV-MAGNUM links to the NRF: 2534579

Fixing Method 1 – Four Ropes

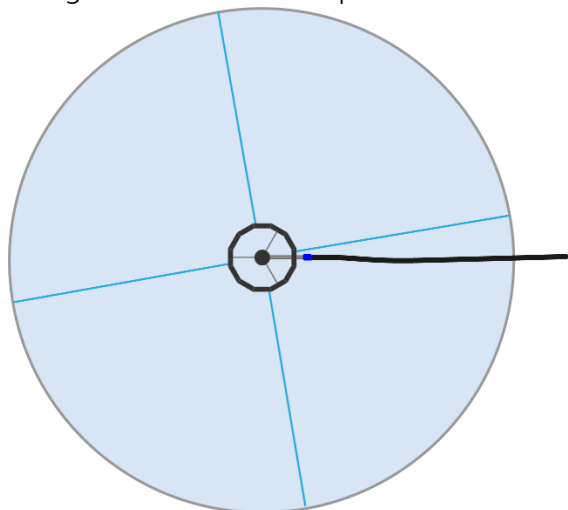

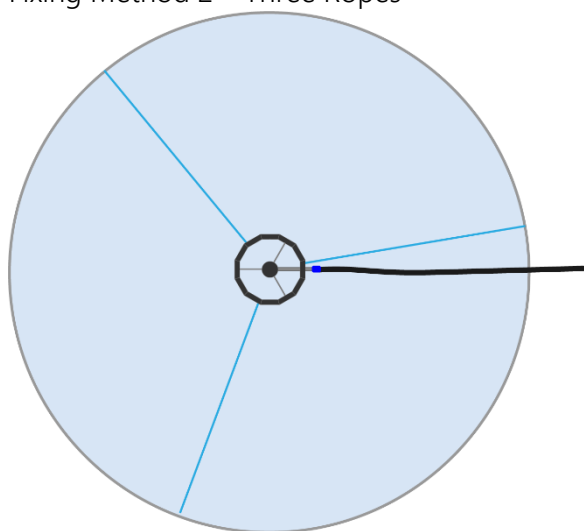

Fixing Method 2 – Three Ropes



6.5 INSTALLATION OF THE LOKE CONESPREDER TO ANOTHER FLOAT

The Loke Conespreder is suitable for these bases:

		
Loke base NorseAqua	Rotorspreder Hex Base AKVA group	RS-90C AKVA group

Loke Conespreder is unsuitable for use on these bases:

		
Scale AQ Rotorspreder	Huber Rotorspreder	Scale AQ RTF 001

Procedure:

1. Unscrew the rotor
2. Attach the Loke Conespreder.
3. Test and adjust the spread until you have the scattering image you want.

7 USE – BEST PRACTICES

7.1 BEFORE FEEDING

1. Wash the chain guide by blowing out water from the water hose.

1. To get a better washing effect, drill holes in the hose just before the link to the Loke base.

7.2 ADJUST SPREAD IMAGE

- 1) Adjust spread image with blow pressure.
 1. Adjust scattering image by moving the spreader
 - a) Loosen the screws in the bracket
 - b) Move the spreader
 - c) Tighten the screws
 - d) Test
 - e) Adjust

8 MAINTENANCE

8.1 PERIODIC INSPECTION AND MAINTENANCE

	Daily	Weekly	Monthly	Generation
Inspect scattering image	X			
Change Cone				X

8.2 SPARE PARTS AND SERVICE

Please contact NorseAqua for ordering spare parts and any service.

8.3 ICING

The product is designed to withstand icing. Much icing can still cause problems. During freezing, you can crush the ice gently, or warm the iced part or replace the part with a new ice-free part.

8.4 STORAGE AND STORAGE

Keep the parts clean. Keep the product dark and dry.

8.5 TRACEABILITY

Please contact NorseAqua. we can track the product from its description.

8.6 CONDITIONS AND LIMITATIONS OF USE

The equipment should be mounted according to the description.

9 SHIPPING

We recommend lifting the product with a crane.

10 QUALITY AND SAFETY

11 STORAGE

Guidelines:

1. Should preferably be stored out of direct sunlight to increase the life of the rope.

12 TROUBLESHOOTING

Problem	Cause	Root cause	Fix

13 ALTERATION, REBUILDING OR EXPANDING

If you need to change the product, please contact NorseAqua.

14 THROWING/DISPOSING

Please contact us for assistance with disposal.

We refer to the waste pyramid as a general guideline for disposing of our products.

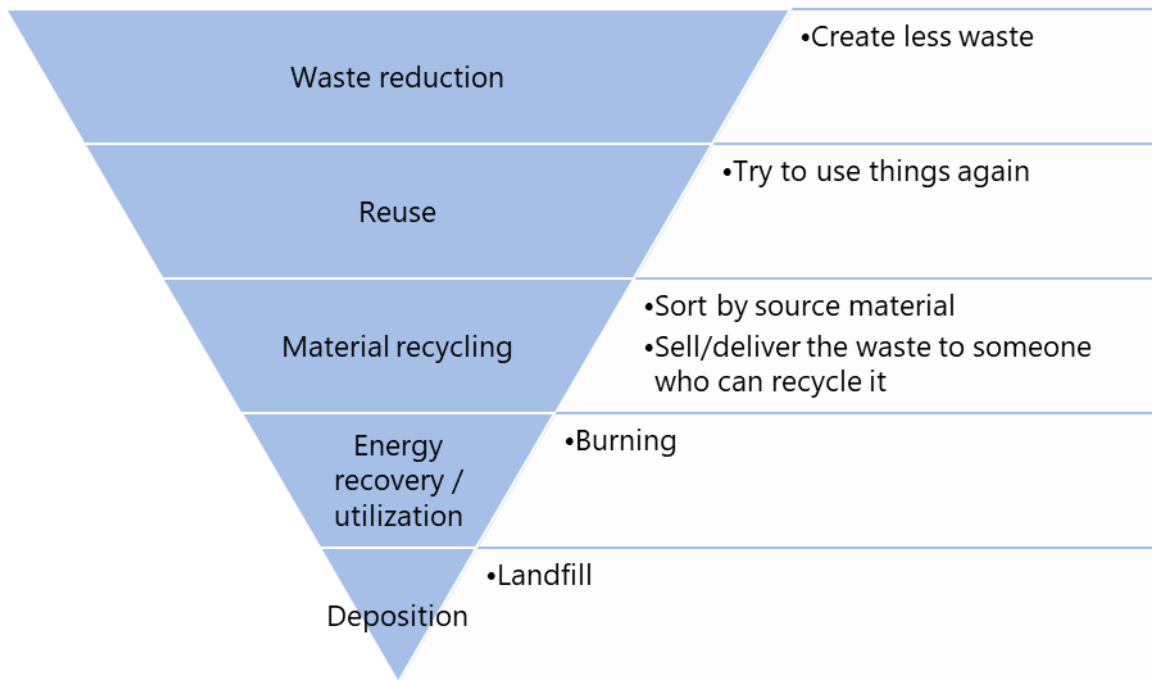

Attachment – Deviation report

Copy this form before you complete it. Deliver it according to your deviation reporting routine and/or send it to NorseAqua at post@norseaqua.no

Product/Service	Supplier	Product nr / Serial nr	Year of purchase

Problem experienced

What has happened? Which problems do you experience because of it?

--

Your proposal for corrective measures

(Reduce the harmful effects when the problem first appears)

--

Your proposal for preventive measures

(Reduce the chance that it happens again later)

--

Date	Your name