

# Mid-Norwegian Ring

# 1 Contents

2	Introduction	3
3	Safety	4
3.1	General safety	4
3.2	Safety measures when using compressed air	4
3.3	Receipt of new equipment	4
3.4	Disinfection of equipment	4
3.5	Personnel safety	4
3.6	Rough weather	5
4	About NorseAqua	5
4.1	Contact information	5
5	About the product	6
5.1	Immaterial rights	6
5.1.1	The solution is patent pending	6
5.2	About the Mid-Norwegian Ring	6
5.3	Components	7
5.3.1	Aerator – Mid-Norwegian Ring	7
5.3.2	Compressor station	7
5.3.3	Flow control valves	7
5.3.4	Manifold	7
5.4	Competence required for use	8
5.5	Identification of the product	8
5.5.2	Expected lifespan	8
5.5.3	Limits for use	8
5.5.4	Strength calculations	8
5.6	Risk assessment of escapes	9
5.6.1	How to determine the risk of escapes	9
5.6.2	Risk matrix – Risk of escapes	9
6	Installation	11

6.1	Time required for installation of aerator _____	11
6.2	Placement in the cage _____	11
6.3	Installation of aerator on cage _____	12
6.3.1	Fixing method 1 – Four ropes to the handrail _____	12
6.3.2	Fixing method 2 – Rope to a float _____	13
6.3.3	Transition from pipe to hose _____	14
6.4	Compressor station _____	14
6.4.1	Installation _____	14
6.4.2	Ventilation to the compressor station _____	14
6.5	Flow control _____	14
6.6	Pipes and hoses _____	14
7	Operation _____	15
7.1	Air flow _____	15
8	Maintenance _____	15
8.1	Periodic inspection/maintenance of aerator _____	15
8.2	Periodic inspection/maintenance of compressor station _____	15
9	Transport _____	16
10	Storage _____	16
11	Faults and Troubleshooting _____	16
11.1	Troubleshooting of Flow control sensor type V420 _____	16
12	Disposal _____	18

## 2 Introduction

This user manual has been written to help you with the following things

Product description

Installation

Use

Maintenance

Transport

Storage

Troubleshooting

Disposal

Our goal is to help you to get the most possible use out of the product in its lifetime and at the same time make sure that no one is exposed to danger.

You do not need any special background to use this. Please contact us if you find things that are unclear and we will help you as well as we can.

## 3 Safety

### 3.1 General safety

This manual describes how you can safely use the product. Tasks/procedures that are not described in this manual should only be carried out by NorseAqua personnel or after written approval from NorseAqua is received. The owner of the site facility where the product is installed is responsible for ensuring that applicable laws and regulations for the country of installation are followed. The owner is also responsible for necessary safety devices and procedures to protect personnel. Those who are going to operate the machine should be familiar with the following:

- How the product works and how it should be used.
- How the product works with the rest of the site facility that it is connected to.
- Which safety aspects must be considered with regard to its use, maintenance and other related tasks.
- How it should be maintained according to the procedures that are named in this manual.

### 3.2 Safety measures when using compressed air

- Use eye protection.
- Use hearing protection.
- Never direct the air jet towards yourself or others.
- When working at the site facility, make sure that the part of the facility you are working on is depressurized before starting work.

### 3.3 Receipt of new equipment

Check that all parts specified in the packing list are delivered. If the order is not complete or something has been damaged during transport, please contact NorseAqua.

### 3.4 Disinfection of equipment

Should equipment, ropes and other associated equipment be moved from one facility to another, it is required by law to disinfect everything to prevent possible infection. We recommend rinsing the equipment with fresh water after disinfection, as disinfectant is often comprised of very strong chemicals which can damage surface materials.

### 3.5 Personnel safety

Everyone who is going to operate the product must familiarize themselves with how the equipment should be used and learn about the dangers incorrect use might lead to. The

owner and operations manager of the site facility are responsible for ensuring that all workers have understood the contents of this manual. Protective equipment, such as non-slip footwear and flotation suits are mandatory when working at the cage edge, for example in connection with installation and maintenance. In order to avoid injury to personnel and damage to equipment during installation, maintenance and repair of the product, it is important to follow all the instructions given by NorseAqua in this manual as well as to comply with the laws and regulations in force in the country in which the equipment is installed.

### 3.6 Rough weather

Check all equipment after a storm and very rough weather. If equipment is damaged, it must be fixed immediately. Contact NorseAqua immediately if needed for assistance in such cases.

## 4 About NorseAqua

NorseAqua aims to be an important contributor to Norway reaching its goal of 5 million tonnes of sustainably produced seafood by 2050.

NorseAqua is therefore working to find solutions to the most important challenges in the aquaculture industry.

We would therefore like to receive your feedback about us and the equipment we deliver. We would like to hear from you if you are experiencing challenges that together we can find good solutions to.

The boss in NorseAqua is the client. We always want to receive feedback about the equipment we deliver and the way in which we work.

### 4.1 Contact information

Company  
NorseAqua AS  
Tel: +47 473 68 943  
[post@norseaqua.no](mailto:post@norseaqua.no)  
Sørfjordveien 5  
7980 Terråk  
Norway  
Organization number:  
916 547 358 MVA

Product Manager  
Martin Munkeby  
+47 484 10 290  
[martin@norseaqua.no](mailto:martin@norseaqua.no)

Sales Lead  
Haakon Lund  
+47 473 68 943  
[haakon@norseaqua.no](mailto:haakon@norseaqua.no)

Marketing Executive  
Simon Kveinå  
+47 480 48 314  
[simon@norseaqua.no](mailto:simon@norseaqua.no)

## 5 About the product

### 5.1 Immaterial rights

#### 5.1.1 The solution is patent pending

NorseAqua has a licence agreement with Midt-Norsk Havbruk, who developed the first version of the Mid-Norwegian Ring. Midt-Norsk Havbruk is committed to contributing to the development of innovative solutions that lead to sustainable growth.

Contact us for information about licensing. <https://norseaqua.no/midt-norsk-ringen-patentet-og-teknologifondet/>

### 5.2 About the Mid-Norwegian ing.

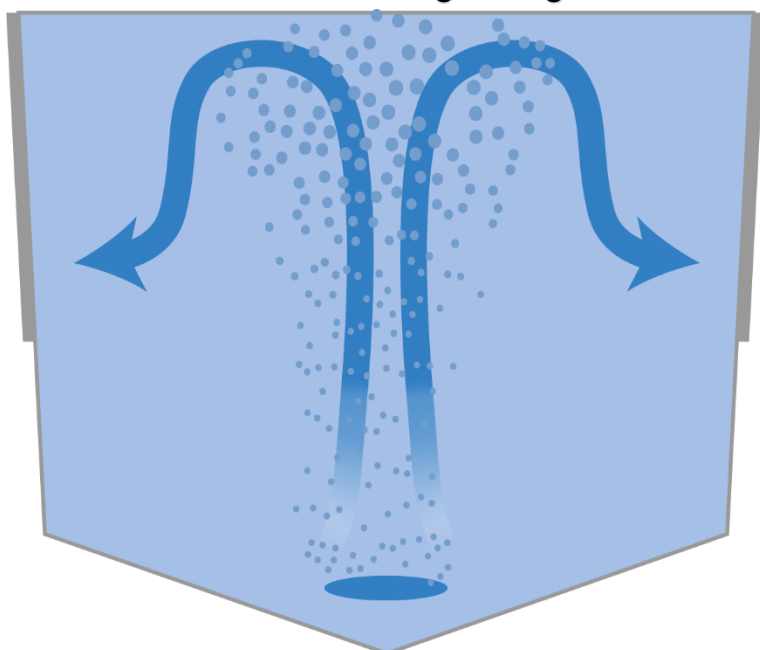

The 'Mid-Norwegian Ring, or aerator, is a way to move water up in a cage. The principle is that air is blown down into a ring which hangs 1–2 metres above the bottom of the net. This ring has many small nozzles that cause many small air bubbles to form. The air bubbles drag the water along and create an ascending water flow over the ring.

## 5.3 Components



### 5.3.1 Aerator – Mid-Norwegian Ring

The aerator distributes the compressed air in the water.

#### 5.3.1.1 Specifications

Parameter/Component	Value	Description
Diameter	1–3 m	
Weight	36 kg	Only aerator
	71 kg	Aerator with rope and suspension
Fixing rope	4 × 55 m	Fixing
	220 m	Total length (× 4 ropes)
Material	Polyethylene	Ring's main material

#### 5.3.1.2 Strength testing

- The aerator can withstand a load of 100 kg air.
- The aerator has been tested with 8 bar.

### 5.3.2 Compressor station

The compressor station produces and cleans compressed air.

### 5.3.3 Flow control valves

The flow control valves regulate the amount of air to each aerator.

### 5.3.4 Manifold

The manifold transports the compressed air to the aerators.



## 5.4 Competence required for use

Installation of the aerator requires no training other than that which is written in this user manual.

## 5.5 Identification of the product

### 5.5.1.1 *Aerator*

Contact NorseAqua to identify the product by order number.

### 5.5.1.2 *Compressor station*

Follow the manufacturer's instructions to identify the product.

### 5.5.1.3 *Flow control*

Contact NorseAqua for identification of the product.

### 5.5.1.4 *Manifold*

The components are marked individually

### 5.5.2 Expected lifespan

The product is expected to function for 36 months in the sea.

### 5.5.3 Limits for use

	Values	Comment
<i>Significant wave height (<math>H_s</math>)</i>	4	
<i>Depth in the sea (m)</i>	35	Aerator is weighted to be used down to a depth of 35 metres
<i>Current (m/s)</i>	1.2	Aerator can be inclined at an angle of 45 degrees without problems
<i>Wind (m/s)</i>	40	
<i>Ice (cm/day)</i>	5	

These limits assume correct installation and operation.

### 5.5.4 Strength calculations

Strength calculations and analyses provided on request.

## 5.6 Risk assessment of escapes

### 5.6.1 How to determine the risk escapes

Point	How likely is the accident to occur?		How serious will the consequences be if the accident occurs?	
	Example	Example	Example	Example
5	Extremely likely	Monthly	Extremely serious	Escapes at facility level can occur
4	Very likely	Once a year or more often	Serious	Escapes at cage level can happen in special cases
3	Likely	Once every 5 years	Moderate	Individual escapes can happen
2	Less likely	Once every 10 years or more often	Potential	Individual escapes can happen in extremely special cases
1	Unlikely	Rarer than every 10 years	Insignificant	Insignificant risk

### 5.6.2 Risk matrix – Risk of escapes

Point	Danger	Reason for danger	Likelihood		Risk	Measures
1	Chafing on net	Two fixing ropes loosen and the ring hangs in the net	1	4	4	Correct fixing and inspection. The aerator is made such that it hangs free at the desired depth. The aerator has no sharp edges.
2	Tearing of net	Damage to the ring exposes sharp edges that	1	4	4	Correct fixing and inspection with underwater camera

		come into contact with the net				
3	Can fall into the net, be hanging against the net	Suspense in failure.	1	4	4	Inspection with underwater camera
4	Deformation of main component	Too heavy load on the handrail if the ring hooks into other components	2	4	8	Inspection with underwater camera
5	Secondary damage to main component	–	0	0	0	
6	Short circuit and fire (net and float collar)	–	0	0	0	
7	Water intrusion (power cabinet for components)	–	0	0	0	
8	Icing hazard	Icing on ropes causes them to loosen or overload the handrail.	1	4	4	Breaking/melting of ice.
9	Corrosion, loss of initial strength	Negligible weakening in components due to corrosion and sun damage in the product's lifetime.	1	4	4	Inspection
10	Production defects, fatigue	Production defects can cause breakage in special cases.	2	4	8	Welding inspection in production
11	Different practices for installation and operation	Increases likelihood of the dangers mentioned above	3	4	12	Good user manual. Offer assistance with installation.
12	Not notice / not notify about the accident	Increases likelihood of the dangers mentioned above.	3	4	12	Good user manual. Offer assistance with installation.

## 6 Installation

### 6.1 required for installation of aerator

The user should expect to spend 13 hours per unit for installation.

### 6.2 Maintenance

When cleaning the Mid-Norwegian Ring it's important to have continual air flow in the ring to avoid blocking the nozzles-

### 6.3 Placement in the cage

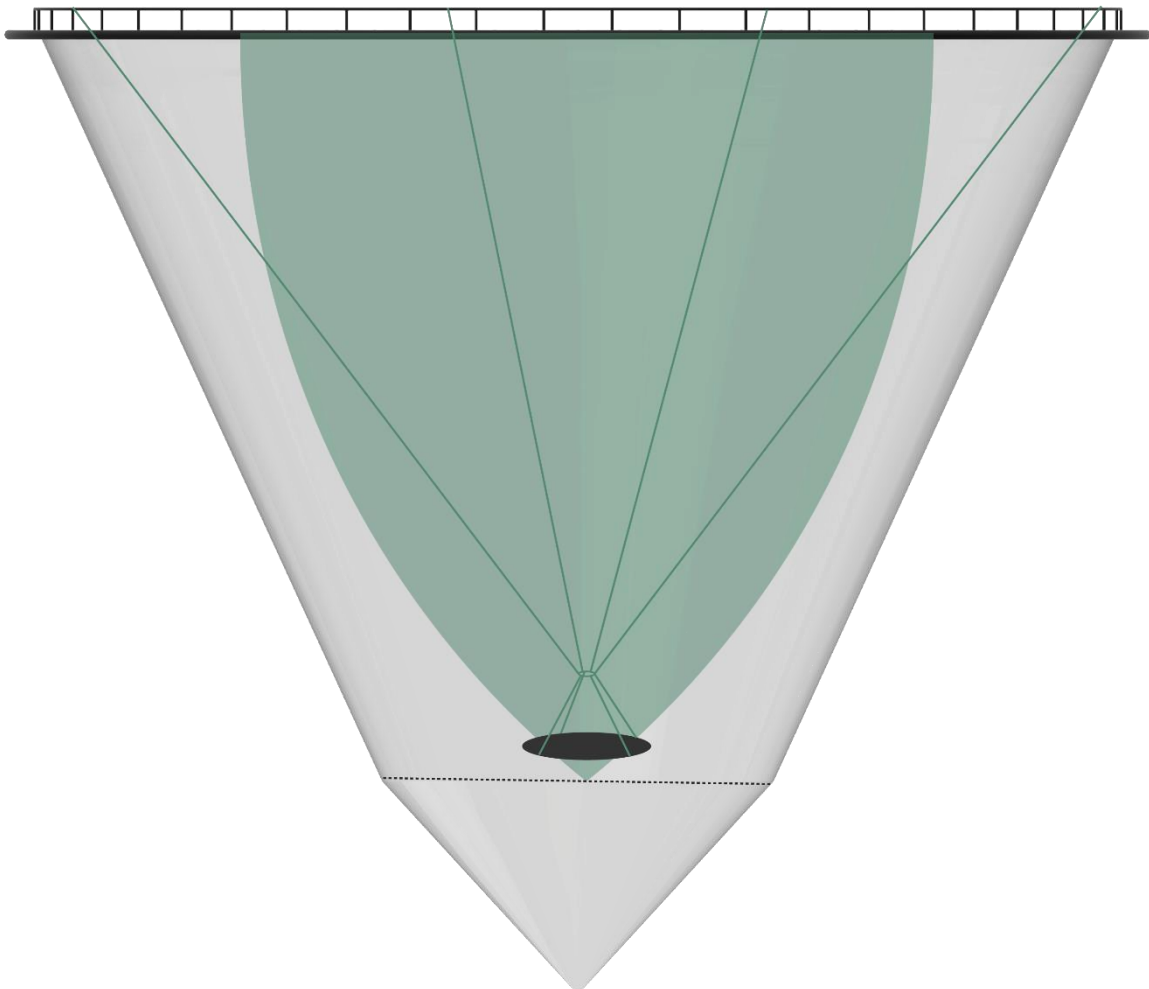

A coned net is the kind of net that is most likely to come into contact with the ring in strong currents. Therefore it is important that the following guidelines are followed:

- The ring can be placed in the green area to prevent contact with the net in strong currents.
- The ring should not be used deeper than the bottom rope on the net and never deeper than 35 metres.

## 6.4 Installation of aerator on cage

- 1) To avoid conflict with any other equipment such as the Liftup system and feed spreaders, place the ring to the side.
- 2) Inspect the ring with an underwater camera during and after installation.
- 3) Lash the air hose around the handrail at least twice before connecting the hose to the air pipe.

### 6.4.1 Fixing method 1 – Four ropes to the handrail

This is our recommended fixing method as this is the most secure and lets you have thering deeper.

- 1) The ring is delivered with four ropes for fixing of the aerator.
  - a) The ropes are attached to the handrail with an angle of 90 degrees between each rope.

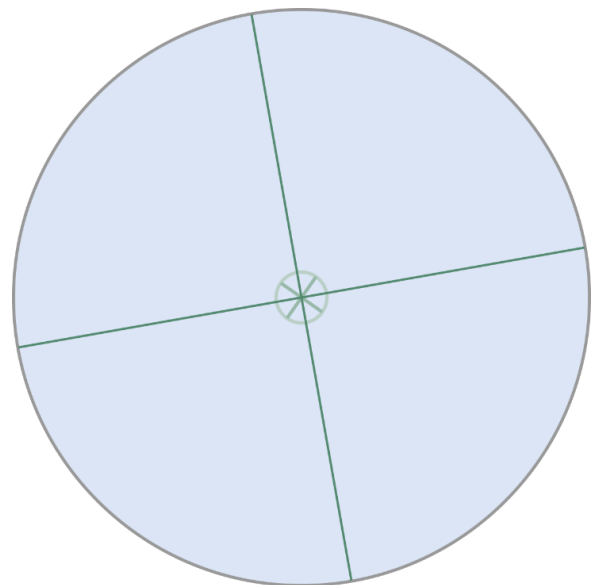

- b) To avoid conflict with other equipment such as the Liftup system and feed spreader it is usual to place it a little the side of centre in the cage.

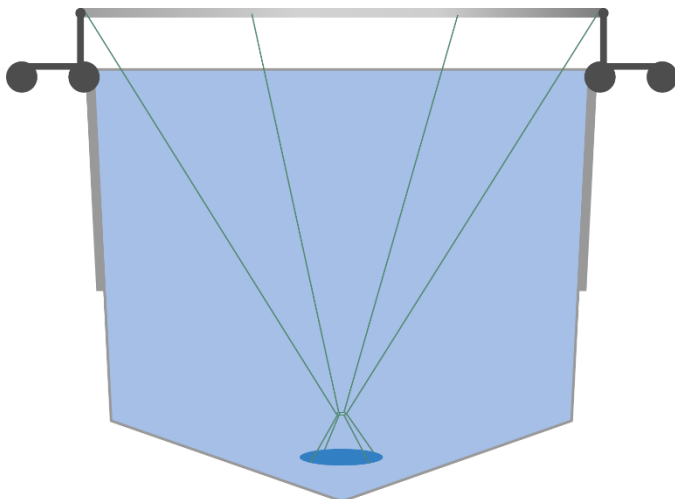

#### 6.4.2 Fixing method 2 – Rope to a float

##### 6.4.2.1 Limitations of the use of method 2

Cage circumference (m)	Depth limitation of the ring (m)
160	19
120	15
90	11

##### 6.4.2.2 Guidelines

#### 4) Remove three of the ropes.

- Attach the rope to a float with a buoyancy of at least 34 kg.
- Attach at least two ropes from the float to the handrail.

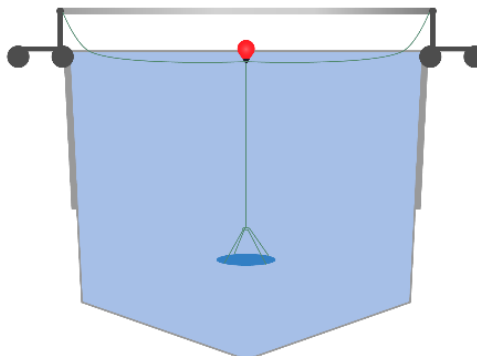
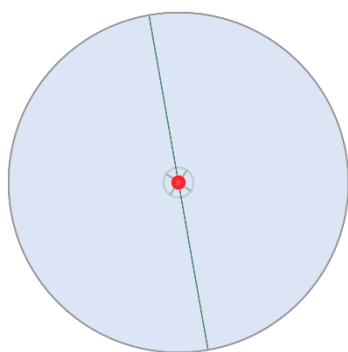

### 6.4.3 Transition from pipe to hose

We recommend using a transition on the cage with a ball valve to shut off the air. This can be delivered as an option.

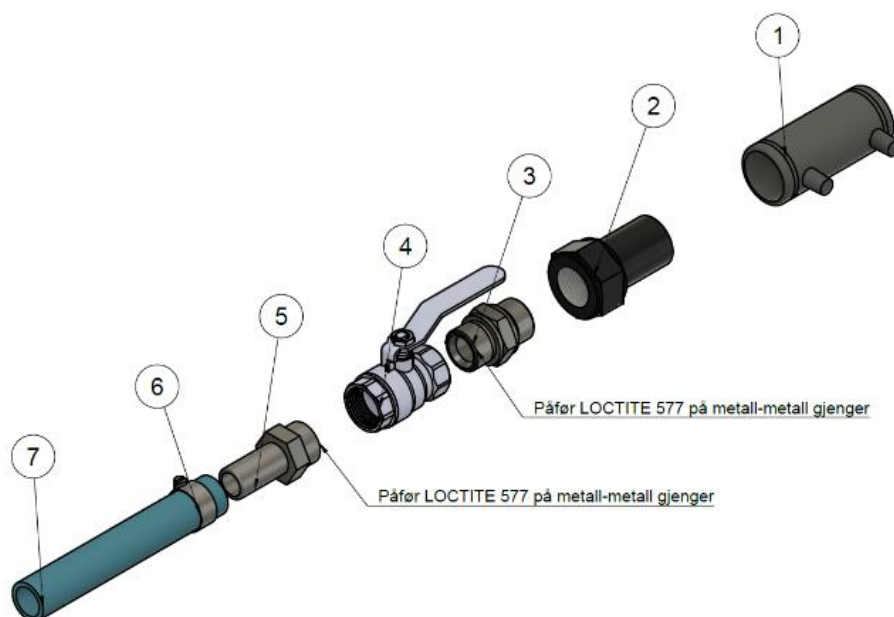

*Transition from 32 mm polyethylene pipe to 19 mm hose*

## 6.5 Compressor station

### 6.5.1 Installation

Ensure professional installation of the compressor station.

### 6.5.2 Ventilation to the compressor station

Compressors with pressure over 3 bar expel considerably more heat to the room than low pressure blower. It is therefore important to provide adequate ventilation so that the surplus heat from the compressors escapes. If desired, this heat can be used to heat adjacent rooms.

## 6.6 Flow contro

Ensure professional installation of the flow control.

## 6.7 Pipes and hoses

Ensure that pipes and hoses are tight by looking for bubbles during installation.

## 7 Operation

### 7.1 Air flow

- The Mid-Norwegian Ring version 1 has a standard air flow of 500 litres/minute compressed air.
- The Mid-Norwegian Ring version 2 has a standard air flow of 360 litres/minute compressed air.

## 8 Maintenance

### 8.1 Periodic inspection/maintenance of aerator

	Daily	Weekly	Monthly	Fish eneration
Check that air is coming out of the ring	X			
Inspect the rings placement with a camera		X		
Inspect the rope on the railing pipe		X		

### 8.2 Periodic inspection/maintenance of compressor station

Follow the manufacturer's guidelines.

	Daily	Weekly	Monthly	Fish eneration
Empty condensate	X			
Check that the temperature does not exceed 35°C	X			
Look for air leakage from the pipes				X

#### 8.2.1.1 *Temperature in the compressor room*

For skrew compressors, 96% of the applied power is lost as heat. On hot summer days the room can overheat.

This has several negative effects:

- The oil in the compressor breaks down faster.
- You get more water in the air.
- You use more energy.

To counteract high temperatures we recommend that you:

1. Open an air duct which leads the exhaust air from the compressor away. This must not cover the refrigerant dryer if it is installed.
2. Open hatches for more supply air.



3. Install an extractor fan. This can be thermostatically controlled.

The user is responsible for maintenance and service of the compressors and associated components. The user must follow the manufacturer's guidelines. NorseAqua recommends signing a service agreement with a compressor manufacturer, service centre or distributor.

## 9 Transport

Can be lifted by crane if desired.

## 10 Storage





Guidelines:

- Should preferably be stored out of the sun to increase the life of the hoses and ropes.

## 11 Faults and Troubleshooting

Contact NorseAqua to report deviations. See attached deviation report.

### 11.1 Troubleshooting of Flow control sensor type V420

Problem	Cause	Root cause	Solution
 <p>The flow meter shows nothing or an illogically large value</p>	 <ul style="list-style-type: none"> <li>• Sensor head is easily contaminated.</li> <li>• The pipe is full of water.</li> </ul>	<ul style="list-style-type: none"> <li>• Dirt has entered the system during construction.</li> <li>• The compressor room is warm and damp.</li> </ul>	<p>Corrective measures:</p>  <ol style="list-style-type: none"> <li>1. Clean the sensor in soapy water. Do not use a brush or anything else that can damage the sensor.</li> <li>2. If this does not help, contact NorseAqua.</li> </ol>
 <p>Flow meter shows 'Heater error'</p>	 <p>Sensor head is heavily contaminated</p>		

			 <p>Preventive measures:</p> <ol style="list-style-type: none"><li>1. Close the air and remove the sensor head.</li><li>2. Blow out dirt and water from the system. Open one or more valves in the flow cabinet without the sensor units mounted in. Use hearing protection and protective goggles.</li><li>3. Check that the condensate is led away collected in the compressor room.</li><li>4. Make sure that the temperature in the compressor room is lower than 35°C. This gives less water in the</li></ol>
--	--	--	---

			compressed air. 5. Install the refrigerant dryer.
--	--	--	--

For other errors, contact the supplier.

- A damaged aerator not be put out in the cage. Doing so poses a risk of injury to the fish at the same time as increasing the risk of escapes case of contact with the net.
- If the aerator touches the net or other equipment, this must be corrected at once as this can result in escapes or other unwanted events.
- When the compressor stops, you can get lower oxygen in the cage. Refer to the breeder's risk assessment to see which measures are required.

## 12 Disposal

Contact NorseAqua for assistance with disposal.

We refer to the waste pyramid as a general guideline for disposal of our products.

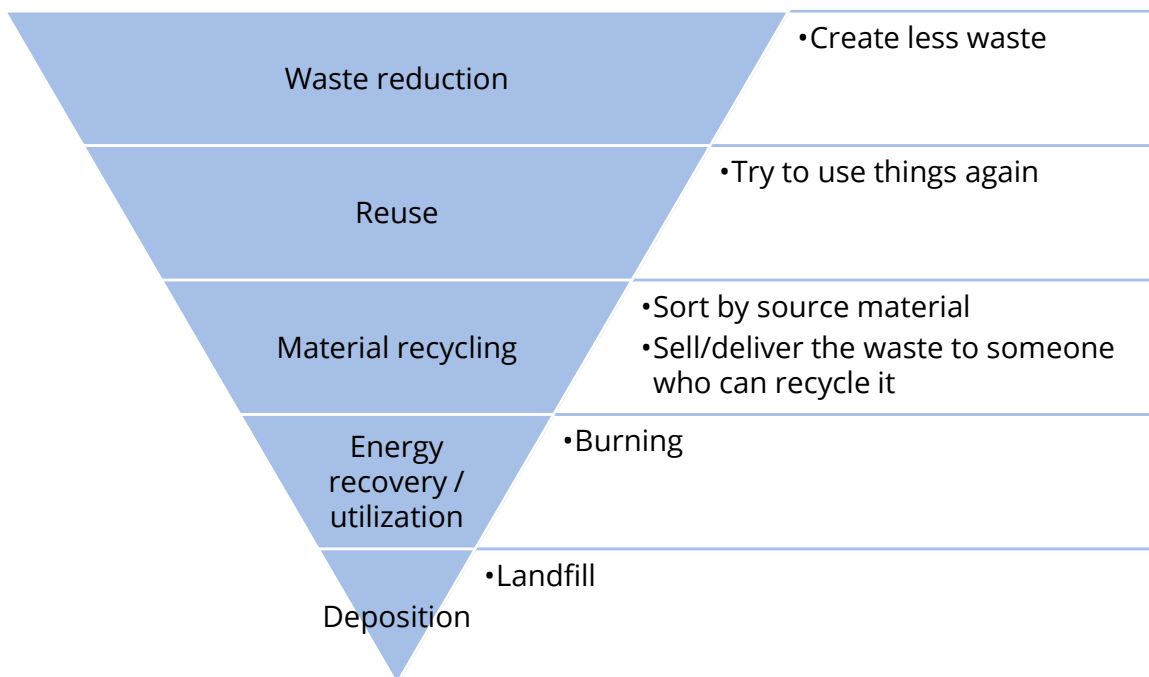

# Attachment Deviation report

Copy this form before you complete it. Deliver it according to your deviation reporting routine and/or send it to NorseAqua at post@norseaqua.no

Product/Service	Supplier	Product nr / Serial nr	Year of purchase

## Problem experienced

What has happened? Which problem do you experience because of it?

--

## Your proposal for corrective measures

(Reduce the harmful effects when the problem first appears.)

--

## Your proposal for preventive measures

(Reduce the chance that it happens again later.)

--

Date	Your name